

G-KRRB Two Seals
Spherical O.D.

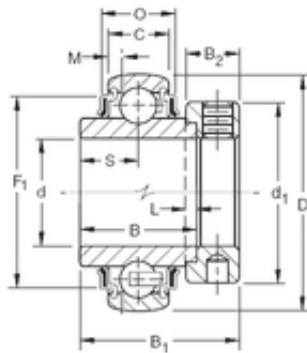

Bearing No. G1204KRRB

P	35,03 mm
S	31 mm
d	57,15 mm
D	110 mm
B	61,91 mm
C	27 mm
O	94,89 mm
L	6,4 mm
F1	77,8 mm
d1	84,1 mm
B1	5,13 mm
B2	22,2 mm
Weight	2,041 Kg
Size (mm)	57.15x110x61.91
Width (mm)	61,91
Bearing number	G1204KRRB
Bore Diameter (mm)	57,15
Outer Diameter (mm)	110
Basic dynamic load rating (C)	58,8 kN