

KRR Two Seals
Cylindrical O.D.

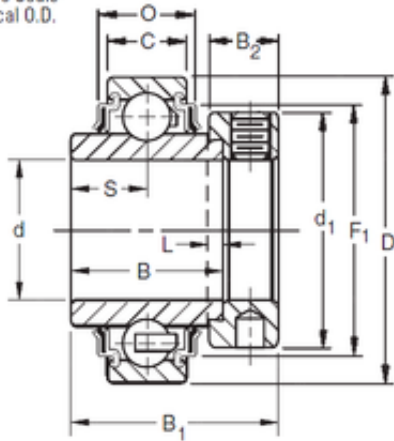

Bearing No. E30KRR

P	17,78 mm
S	18,3 mm
d	30 mm
D	62 mm
B	36,51 mm
C	16 mm
O	19,56 mm
L	4 mm
F1	52,53 mm
d1	44,4 mm
B1	48,4 mm
B2	15,9 mm
Weight	0,376 Kg
Size (mm)	30x62x36.51
Width (mm)	36,51
Bearing number	E30KRR
Bore Diameter (mm)	30
Outer Diameter (mm)	62
Basic dynamic load rating (C)	21,2 kN