

KRR Two Seals
Cylindrical O.D.

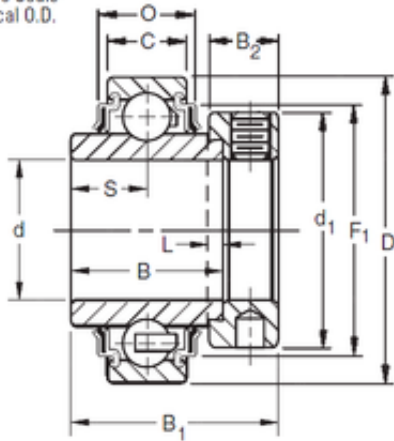

Bearing No. E40KRR

P	19,28 mm
S	21,4 mm
d	40 mm
D	80 mm
B	42,86 mm
C	18 mm
O	20,45 mm
L	4,8 mm
F1	67,79 mm
d1	60,3 mm
B1	56,4 mm
B2	18,3 mm
Weight	0,739 Kg
Size (mm)	40x80x42.86
Width (mm)	42,86
Bearing number	E40KRR
Bore Diameter (mm)	40
Outer Diameter (mm)	80
Basic dynamic load rating (C)	36 kN