

KRR Two Seals
Cylindrical O.D.

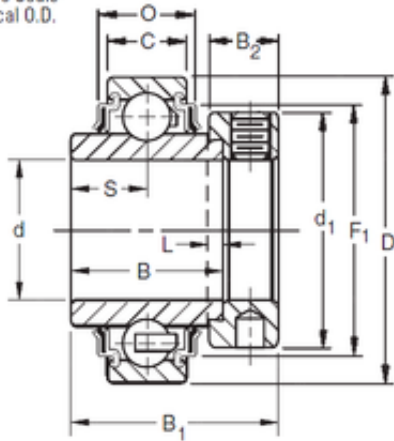

Bearing No. E45KRR

P	21,59 mm
S	21,4 mm
d	45 mm
D	85 mm
B	42,86 mm
C	19 mm
O	24,18 mm
L	4,8 mm
F1	73,86 mm
d1	63,5 mm
B1	56,4 mm
B2	18,3 mm
Weight	0,825 Kg
Size (mm)	45x85x42.86
Width (mm)	42,86
Bearing number	E45KRR
Bore Diameter (mm)	45
Outer Diameter (mm)	85
Basic dynamic load rating (C)	36 kN