

KRR Two Seals
Cylindrical O.D.

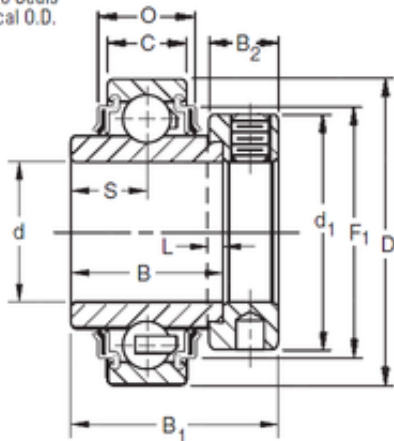

Bearing No. E17KRR

P	14,27 mm
S	13,9 mm
d	17 mm
D	40 mm
B	27,78 mm
C	12 mm
O	16,56 mm
L	4 mm
F1	34,01 mm
d1	28,6 mm
B1	37,3 mm
B2	13,5 mm
Weight	0,122 Kg
Size (mm)	17x40x27.78
Width (mm)	27,78
Bearing number	E17KRR
Bore Diameter (mm)	17
Outer Diameter (mm)	40
Basic dynamic load rating (C)	10,7 kN