

Bearing No. 6305-2NKE

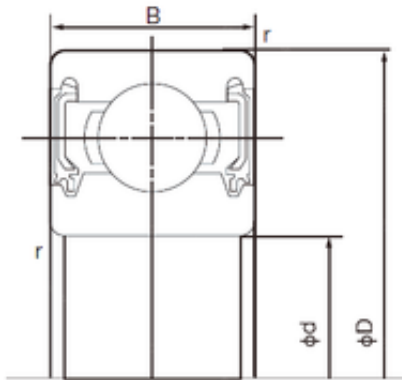

D	62 mm
d	25 mm
B	17 mm
C	17 mm
r min.	1.1 mm
Weight	0.232 Kg
da min.	32 mm
Da max.	55 mm
ra max.	1.0 mm
Size (mm)	25x62x17
Width (mm)	17
Bearing number	6305-2NKE
Bore Diameter (mm)	25
Outer Diameter (mm)	62
Basic dynamic load rating (C)	23,6 kN
Basic static load rating (C0)	12,1 kN