

Bearing No. 6908-2NKE

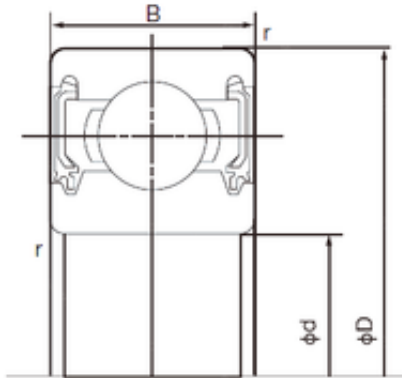

D	62 mm
d	40 mm
B	12 mm
C	12 mm
r min.	0.6 mm
Weight	0.108 Kg
da min.	44 mm
Da max.	58 mm
ra max.	0.6 mm
Size (mm)	40x62x12
Width (mm)	12
Bearing number	6908-2NKE
Bore Diameter (mm)	40
Outer Diameter (mm)	62
Basic dynamic load rating (C)	13,7 kN
Basic static load rating (C0)	9,95 kN