

Bearing No. 6907-2NKE

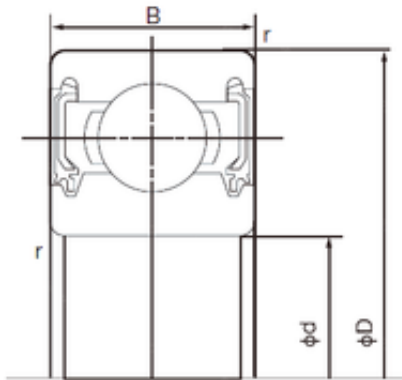

D	55 mm
d	35 mm
B	10 mm
C	10 mm
r min.	0.6 mm
Weight	0.073 Kg
da min.	39 mm
Da max.	51 mm
ra max.	0.6 mm
Size (mm)	35x55x10
Width (mm)	10
Bearing number	6907-2NKE
Bore Diameter (mm)	35
Outer Diameter (mm)	55
Basic dynamic load rating (C)	10,4 kN
Basic static load rating (C0)	7,15 kN