

Bearing No. 6905-2NKE

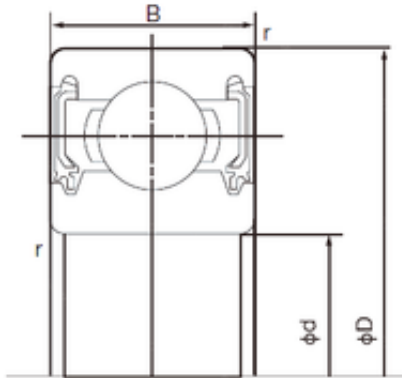

D	42 mm
d	25 mm
B	9 mm
C	9 mm
r min.	0.3 mm
Weight	0.042 Kg
da min.	27 mm
Da max.	40 mm
ra max.	0.3 mm
Size (mm)	25x42x9
Width (mm)	9
Bearing number	6905-2NKE
Bore Diameter (mm)	25
Outer Diameter (mm)	42
Basic dynamic load rating (C)	7 kN
Basic static load rating (C0)	4,5 kN