

Bearing No. 6902-2NKE

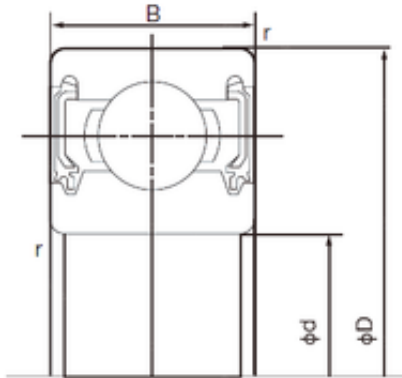

D	28 mm
d	15 mm
B	7 mm
C	7 mm
r min.	0.3 mm
Weight	0.016 Kg
da min.	17 mm
Da max.	26 mm
ra max.	0.3 mm
Size (mm)	15x28x7
Width (mm)	7
Bearing number	6902-2NKE
Bore Diameter (mm)	15
Outer Diameter (mm)	28
Basic dynamic load rating (C)	4,3 kN
Basic static load rating (C0)	2,25 kN