

Bearing No. 6810-2NKE

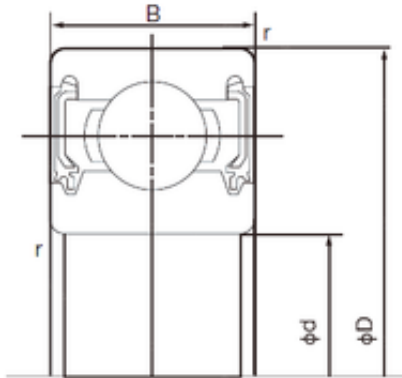

D	65 mm
d	50 mm
B	7 mm
C	7 mm
r min.	0.3 mm
Weight	0.052 Kg
da min.	52 mm
Da max.	63 mm
ra max.	0.3 mm
Size (mm)	50x65x7
Width (mm)	7
Bearing number	6810-2NKE
Bore Diameter (mm)	50
Outer Diameter (mm)	65
Basic dynamic load rating (C)	6,4 kN
Basic static load rating (C0)	5,8 kN