

Bearing No. 6809-2NKE

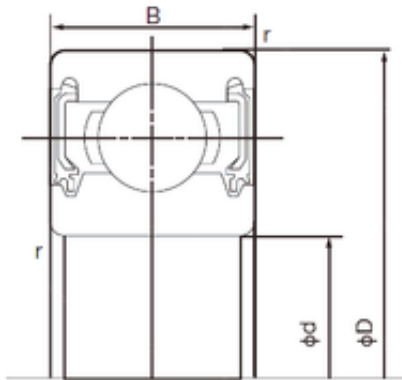

D	58 mm
d	45 mm
B	7 mm
C	7 mm
r min.	0.3 mm
Weight	0.040 Kg
da min.	47 mm
Da max.	56 mm
ra max.	0.3 mm
Size (mm)	45x58x7
Width (mm)	7
Bearing number	6809-2NKE
Bore Diameter (mm)	45
Outer Diameter (mm)	58
Basic dynamic load rating (C)	5,35 kN
Basic static load rating (C0)	4,9 kN