

Bearing No. 6807-2NKE

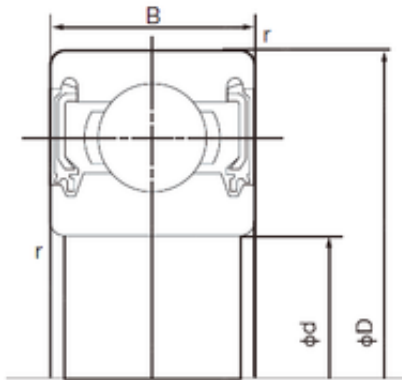

D	47 mm
d	35 mm
B	7 mm
C	7 mm
r min.	0.3 mm
Weight	0.029 Kg
da min.	37 mm
Da max.	45 mm
ra max.	0.3 mm
Size (mm)	35x47x7
Width (mm)	7
Bearing number	6807-2NKE
Bore Diameter (mm)	35
Outer Diameter (mm)	47
Basic dynamic load rating (C)	4,75 kN
Basic static load rating (C0)	3,8 kN