

Bearing No. 6805-2NKE

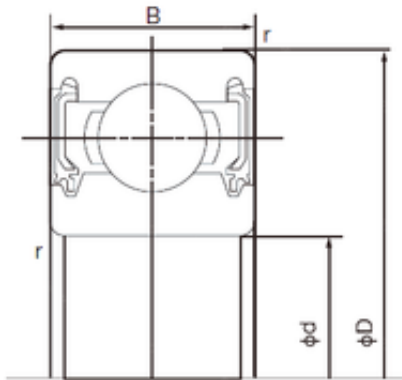

D	37 mm
d	25 mm
B	7 mm
C	7 mm
r min.	0.3 mm
Weight	0.022 Kg
da min.	27 mm
Da max.	35 mm
ra max.	0.3 mm
Size (mm)	25x37x7
Width (mm)	7
Bearing number	6805-2NKE
Bore Diameter (mm)	25
Outer Diameter (mm)	37
Basic dynamic load rating (C)	4,3 kN
Basic static load rating (C0)	2,94 kN