

Bearing No. 6802-2NKE

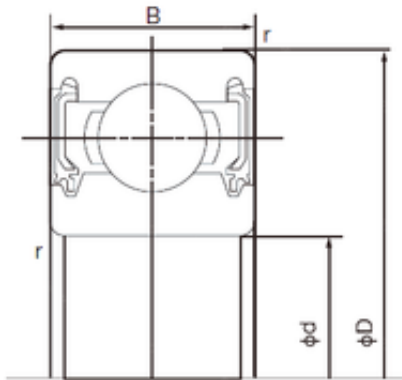

D	24 mm
d	15 mm
B	5 mm
C	5 mm
r min.	0.3 mm
Weight	0.007 Kg
da min.	17 mm
Da max.	22 mm
ra max.	0.3 mm
Size (mm)	15x24x5
Width (mm)	5
Bearing number	6802-2NKE
Bore Diameter (mm)	15
Outer Diameter (mm)	24
Basic dynamic load rating (C)	2,08 kN
Basic static load rating (C0)	1,26 kN