

Bearing No. B-1212

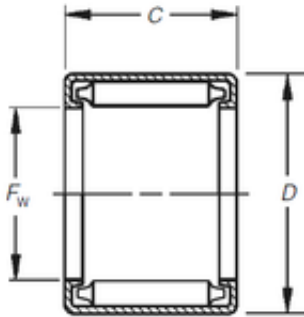

D	25,4 mm
C	19,05 mm
F _w	19,05 mm
Weight	0,024 Kg
Size (mm)	19.05x25.4x19.05
Width (mm)	19,05
Bearing number	B-1212
Bore Diameter (mm)	19,05
Outer Diameter (mm)	25,4
(Grease) Lubrication Speed	3600 r/min
Basic dynamic load rating (C)	21,9 kN
Basic static load rating (C ₀)	38,7 kN