

KRR Two Seals
Cylindrical O.D.

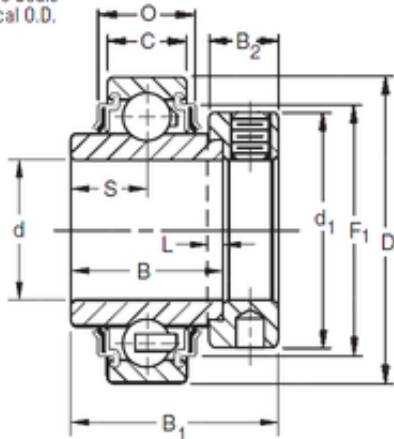

Bearing No. 1100KRR

P	15,82 mm
S	17,5 mm
d	25,4 mm
D	52 mm
B	34,92 mm
C	15 mm
O	16,66 mm
L	4 mm
F1	45,19 mm
d1	38,1 mm
B1	44,1 mm
B2	13,5 mm
Weight	0,231 Kg
Size (mm)	25.4x52x34.92
Width (mm)	34,92
Bearing number	1100KRR
Bore Diameter (mm)	25,4
Outer Diameter (mm)	52
Basic dynamic load rating (C)	15,8 kN