

KRR Two Seals
Cylindrical O.D.

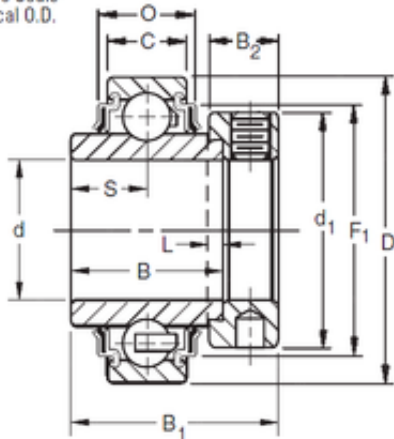

Bearing No. 1207KRR

P	26,01 mm
S	31 mm
d	61,9125 mm
D	110 mm
B	61,91 mm
C	22 mm
O	30,02 mm
L	6,4 mm
F1	94,89 mm
d1	84,1 mm
B1	77,8 mm
B2	22,2 mm
Weight	1,565 Kg
Size (mm)	61.9125x110x61.91
Width (mm)	61,91
Bearing number	1207KRR
Bore Diameter (mm)	61,9125
Outer Diameter (mm)	110
Basic dynamic load rating (C)	58,5 kN