

Bearing No. PBR5FN

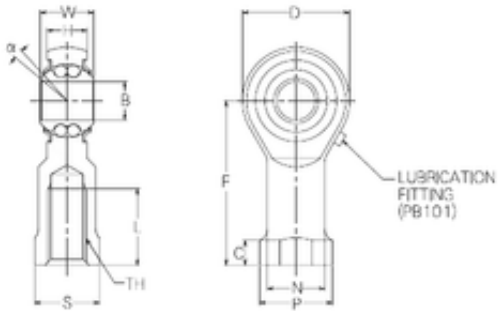

H	6,75 mm
d	5 mm
P	11 mm
B	5 mm
C	4 mm
D	18 mm
F	27 mm
L	14 mm
N	9 mm
S	9 mm
W	8 mm
Angle	5,5 °
Weight	20 Kg
Width (mm)	5
Thread (TH)	M5x0,8
Bearing number	PBR5FN
Bore Diameter (mm)	5
Basic dynamic load rating (C)	1,15 kN