

Bearing No. AST650 F637580

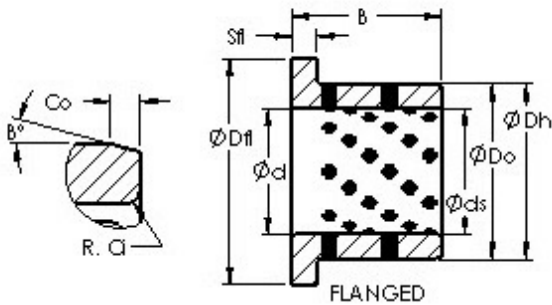

Material	Cast bronze with solid lubricant inserts.
Bearing Type	flanged
Bearing number	AST650 F637580
Bore Diameter (mm)	63
Outer Diameter (mm)	75
OD Chamfer Length (Co)	2.000
ID Chamfer Length (Ci)	1.200
Shaft Dia., Nominal (d)	63.0000
Flange Dia. (Dfl pm 0.5)	85.000
ID Chamfer Angle (B deg.)	15
Bearing Length, Nominal (B)	80.000
Bearing Bore after Mounting (di)	63 +0.080 / +0.030
Bearing Outside Diameter, Nominal(Do)	75.000
Housing Bore Dia. (Dh) - 75 +0.030 / -0	75 +0.030 / 0
Bearing Outside Diameter Tolerance (Do tol.)	75 +0.030 / +0.011
Bearing Length Tolerance (B tol.) - -0.10 / -0.30	0.10 / 0.30