

### Bearing No. SAL 25

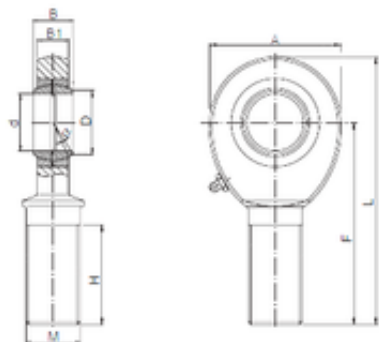

d	25 mm
B	31 mm
A	60 mm
D	29,6 mm
F	94 mm
H	58 mm
L	124 mm
B1	22 mm
Bolt (G)	M24x2
Bearing number	SAL 25
Bore Diameter (mm)	25