

Bearing No. SAL 35

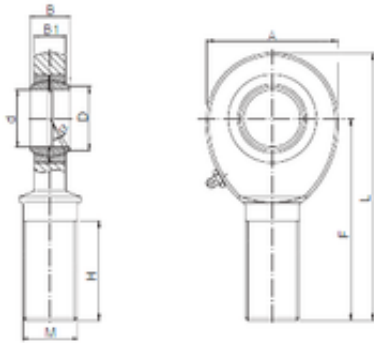

d	35 mm
B	43 mm
A	80 mm
D	37,7 mm
F	125 mm
H	77 mm
L	165 mm
B1	28 mm
Bolt (G)	M36x2
Bearing number	SAL 35
Bore Diameter (mm)	35