

Bearing No. SAL 05

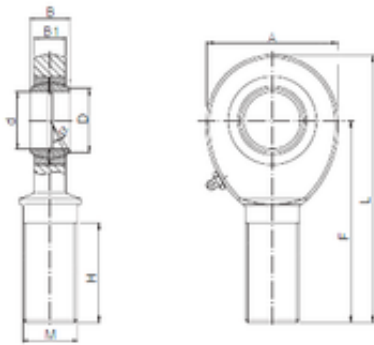

d	5 mm
B	8 mm
A	18 mm
D	7,7 mm
F	33 mm
H	20 mm
L	42 mm
B1	6 mm
Bolt (G)	M5
Bearing number	SAL 05
Bore Diameter (mm)	5