

Bearing No. SAL 06

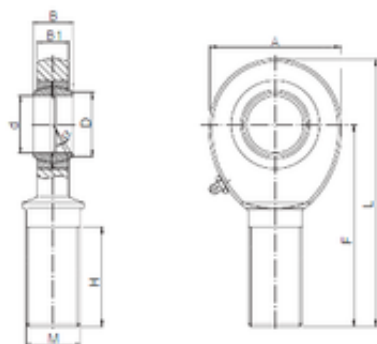

d	6 mm
B	9 mm
A	20 mm
D	8,9 mm
F	36 mm
H	22 mm
L	46 mm
B1	6,75 mm
Bolt (G)	M6
Bearing number	SAL 06
Bore Diameter (mm)	6