

Bearing No. SAL 08

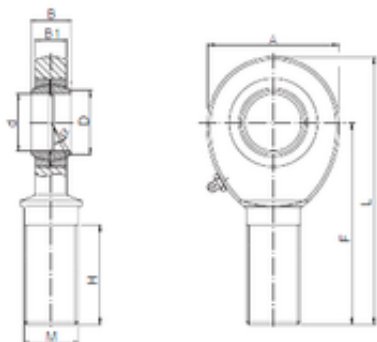

d	8 mm
B	12 mm
A	24 mm
D	10,4 mm
F	42 mm
H	25 mm
L	54 mm
B1	9 mm
Bolt (G)	M8
Bearing number	SAL 08
Bore Diameter (mm)	8