

Bearing No. SAL 16

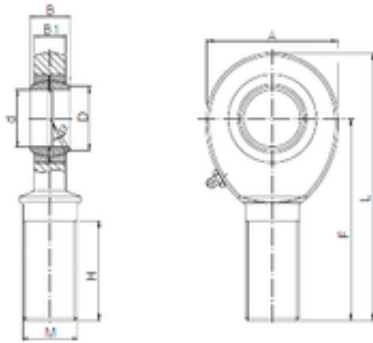

d	16 mm
B	21 mm
A	42 mm
D	19,3 mm
F	66 mm
H	40 mm
L	87 mm
B1	15 mm
Bolt (G)	M16
Bearing number	SAL 16
Bore Diameter (mm)	16