

Bearing No. SAL 20

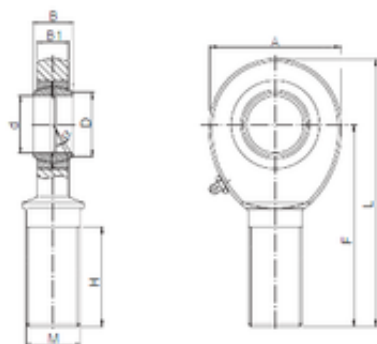

d	20 mm
B	25 mm
A	50 mm
D	24,3 mm
F	78 mm
H	47 mm
L	103 mm
B1	18 mm
Bolt (G)	M20x1,5
Bearing number	SAL 20
Bore Diameter (mm)	20