

Bearing No. 51217

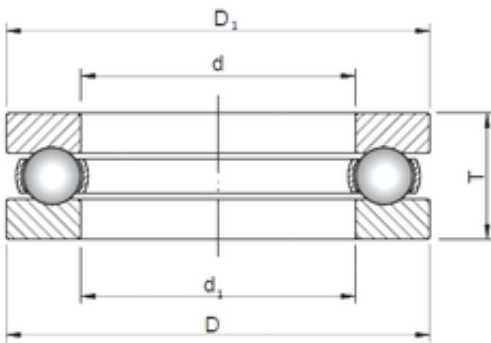

d	85 mm
D	125 mm
T	31 mm
d1	88 mm
D1	125 mm
Weight	1,2 Kg
Bearing number	51217
Bore Diameter (mm)	85
Outer Diameter (mm)	125
(Grease) Lubrication Speed	1600 r/min
Basic dynamic load rating (C)	97,5 kN
Basic static load rating (C0)	250 kN