

Bearing No. 51307

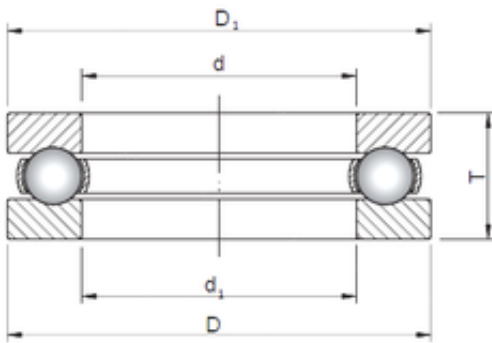

d	35 mm
D	68 mm
T	24 mm
d1	37 mm
D1	68 mm
Weight	0,38 Kg
Bearing number	51307
Bore Diameter (mm)	35
Outer Diameter (mm)	68
(Grease) Lubrication Speed	2400 r/min
Basic dynamic load rating (C)	49,4 kN
Basic static load rating (C0)	88 kN