

Bearing No. RBT3E

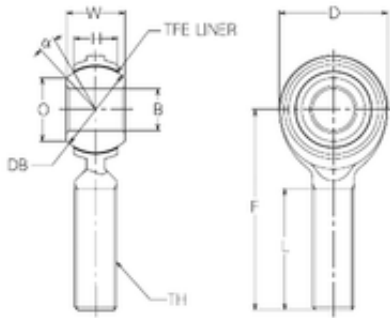

d	3 mm
O	6,8 mm
B	3 mm
D	12 mm
F	27 mm
H	4,5 mm
L	15 mm
W	6 mm
Db	9,04 mm
Angle	11 °
Weight	0,006 Kg
Width (mm)	3
Thread (TH)	M3x0,5
Bearing number	RBT3E
Bore Diameter (mm)	3
Basic static load rating (C0)	1,66 kN