

Bearing No. RBT4E

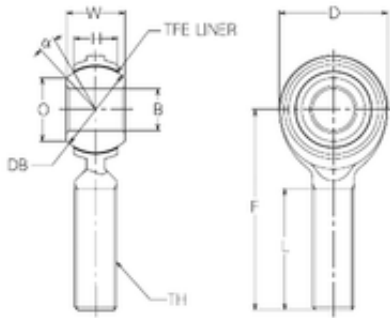

| | |
|-------------------------------|----------|
| d | 4 mm |
| O | 7,6 mm |
| B | 4 mm |
| D | 14 mm |
| F | 30 mm |
| H | 5,25 mm |
| L | 17 mm |
| W | 7 mm |
| Db | 10,32 mm |
| Angle | 12 ° |
| Weight | 0,01 Kg |
| Width (mm) | 4 |
| Thread (TH) | M4x0,7 |
| Bearing number | RBT4E |
| Bore Diameter (mm) | 4 |
| Basic static load rating (C0) | 2,45 kN |