

Bearing No. RBT5E

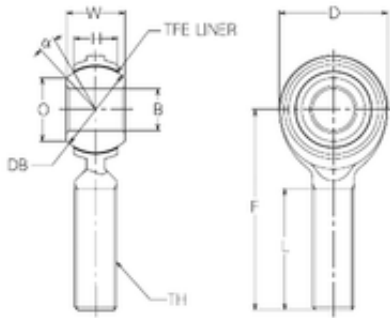

d	5 mm
O	8,8 mm
B	5 mm
D	16 mm
F	33 mm
H	6 mm
L	20 mm
W	8 mm
Db	11,91 mm
Angle	12 °
Weight	0,012 Kg
Width (mm)	5
Thread (TH)	M5x0,8
Bearing number	RBT5E
Bore Diameter (mm)	5
Basic static load rating (C0)	3,92 kN