

Bearing No. RBT8E

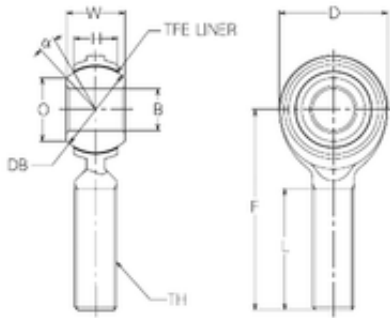

d	8 mm
O	12,7 mm
B	8 mm
D	22 mm
F	42 mm
H	9 mm
L	25 mm
W	12 mm
Db	17,46 mm
Angle	12 °
Weight	0,032 Kg
Width (mm)	8
Thread (TH)	M8x1,25
Bearing number	RBT8E
Bore Diameter (mm)	8
Basic static load rating (C0)	10,78 kN