

Bearing No. 51311

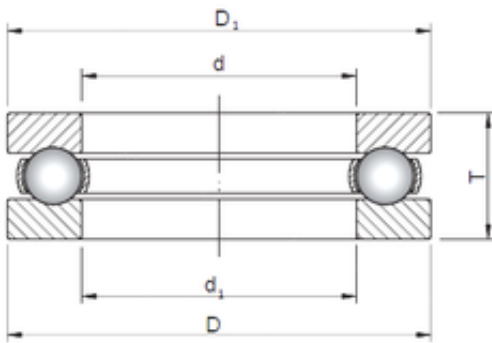

d	55 mm
D	105 mm
T	35 mm
d1	57 mm
D1	105 mm
Weight	1,3 Kg
Bearing number	51311
Bore Diameter (mm)	55
Outer Diameter (mm)	105
(Grease) Lubrication Speed	1600 r/min
Basic dynamic load rating (C)	104 kN
Basic static load rating (C0)	208 kN