

Bearing No. RBT14

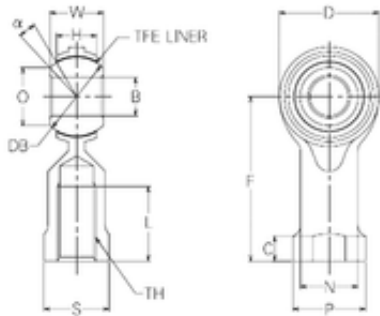

F	57 mm
d	14 mm
P	25 mm
O	19,2 mm
B	14 mm
C	8 mm
D	34 mm
H	13,5 mm
L	27 mm
N	20 mm
S	22 mm
W	19 mm
Db	26,99 mm
Angle	14 °
Weight	0,16 Kg
Thread (TH)	M14x2,0
Bearing number	RBT14
Bore Diameter (mm)	14
Basic static load rating (C0)	26,47 kN