

Bearing No. RBT16E

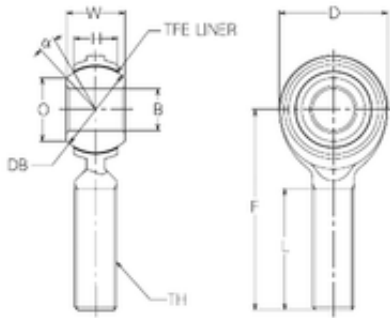

d	16 mm
O	19,4 mm
B	16 mm
D	38 mm
F	66 mm
H	15 mm
L	40 mm
W	21 mm
Db	28,58 mm
Angle	15 °
Weight	0,185 Kg
Width (mm)	16
Thread (TH)	M16x2,0
Bearing number	RBT16E
Bore Diameter (mm)	16
Basic static load rating (C0)	33,34 kN