

Bearing No. RBT18

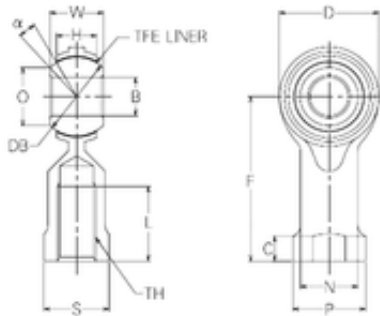

F	71 mm
d	18 mm
P	31 mm
O	21,9 mm
B	18 mm
C	10 mm
D	42 mm
H	16,5 mm
L	36 mm
N	25 mm
S	27 mm
W	23 mm
Db	31,75 mm
Angle	15 °
Weight	0,295 Kg
Thread (TH)	M18x1,5
Bearing number	RBT18
Bore Diameter (mm)	18
Basic static load rating (C0)	46,09 kN