

Bearing No. RBT18E

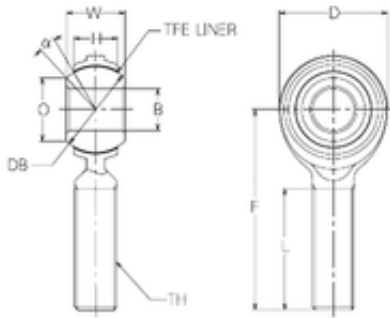

d	18 mm
O	21,9 mm
B	18 mm
D	42 mm
F	72 mm
H	16,5 mm
L	44 mm
W	23 mm
Db	31,75 mm
Angle	15 °
Weight	0,258 Kg
Width (mm)	18
Thread (TH)	M18x1,5
Bearing number	RBT18E
Bore Diameter (mm)	18
Basic static load rating (C0)	46,09 kN