

Bearing No. 51412

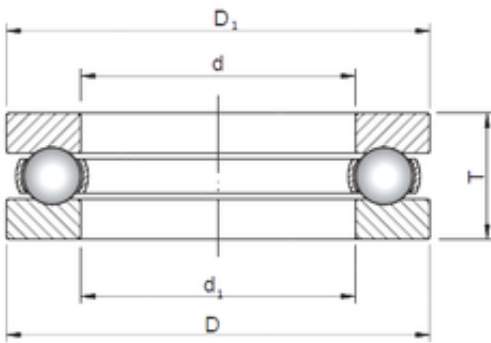

d	60 mm
D	130 mm
T	51 mm
d1	62 mm
D1	130 mm
Weight	3,1 Kg
Bearing number	51412
Bore Diameter (mm)	60
Outer Diameter (mm)	130
(Grease) Lubrication Speed	1100 r/min
Basic dynamic load rating (C)	199 kN
Basic static load rating (C0)	400 kN