

Bearing No. 51415

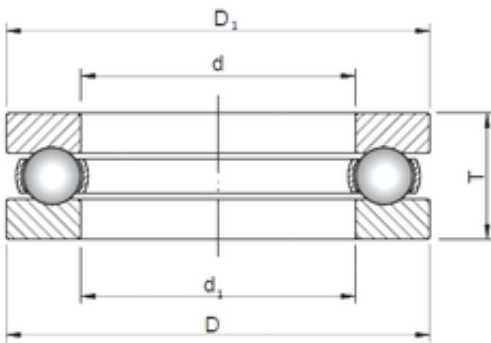

d	75 mm
D	160 mm
T	65 mm
d1	78 mm
D1	160 mm
Weight	6,75 Kg
Bearing number	51415
Bore Diameter (mm)	75
Outer Diameter (mm)	160
(Grease) Lubrication Speed	900 r/min
Basic dynamic load rating (C)	251 kN
Basic static load rating (C0)	560 kN