

Bearing No. PBR22FN

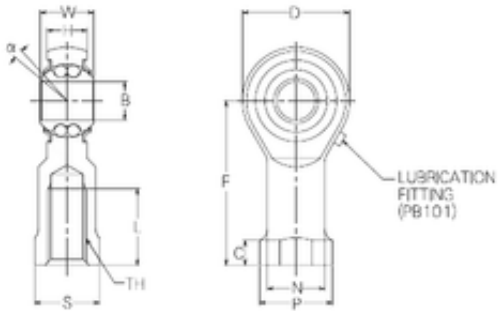

H	20 mm
d	22 mm
P	38 mm
B	22 mm
C	12 mm
D	54 mm
F	84 mm
L	37 mm
N	30 mm
S	32 mm
W	28 mm
Angle	8 °
Weight	480 Kg
Width (mm)	22
Thread (TH)	M22x1,5
Bearing number	PBR22FN
Bore Diameter (mm)	22
Basic dynamic load rating (C)	9,29 kN