

### Bearing No. HRT18

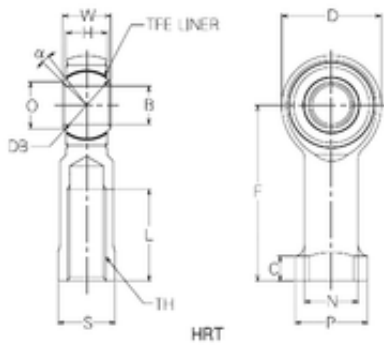

D	43 mm
W	20 mm
d	18 mm
P	30 mm
O	20,4 mm
B	18 mm
C	10 mm
F	74 mm
H	16,3 mm
L	40 mm
N	24 mm
S	26 mm
Db	28,58 mm
Angle	10 °
Thread (TH)	M18x1,5
Bearing number	HRT18
Bore Diameter (mm)	18