

Bearing No. HRT22

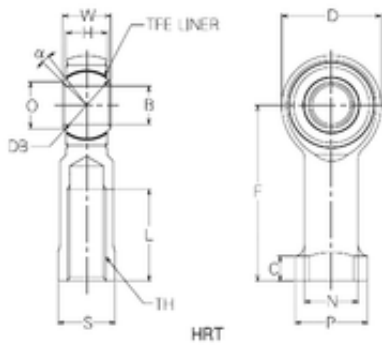

D	52 mm
W	22 mm
d	22 mm
P	36 mm
O	27,1 mm
B	22 mm
C	12 mm
F	85 mm
H	19,3 mm
L	47 mm
N	28 mm
S	30 mm
Db	34,92 mm
Angle	6 °
Thread (TH)	M22x1,5
Bearing number	HRT22
Bore Diameter (mm)	22