

Bearing No. HRT28

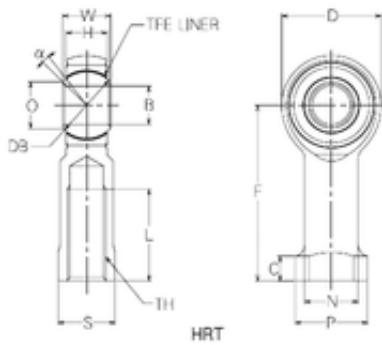

D	75 mm
W	35 mm
d	28 mm
P	56 mm
O	36,8 mm
B	28 mm
C	15 mm
F	110 mm
H	25,3 mm
L	58 mm
N	44 mm
S	47 mm
Db	50,8 mm
Angle	14 °
Thread (TH)	M27×2,0
Bearing number	HRT28
Bore Diameter (mm)	28