

Bearing No. HRT3

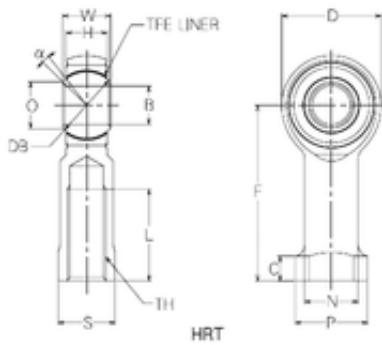

D	16 mm
W	7 mm
d	3 mm
P	9 mm
O	5,2 mm
B	3 mm
C	3,5 mm
F	30 mm
H	5,25 mm
L	16 mm
N	7 mm
S	8 mm
Db	8,73 mm
Angle	18 °
Thread (TH)	M3x0,5
Bearing number	HRT3
Bore Diameter (mm)	3