

Bearing No. RCJTY2-7/16

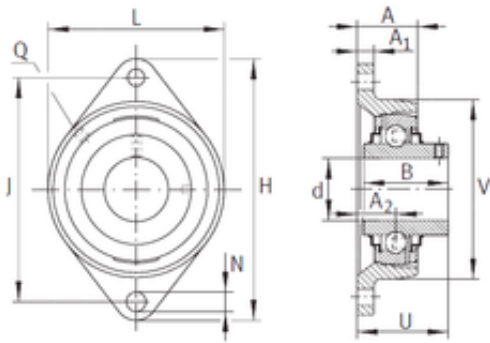

d	61,913 mm
V	140,005 mm
U	73,711 mm
A	49,505 mm
B	65,1 mm
H	238,989 mm
J	202,006 mm
L	140,005 mm
N	18,009 mm
A1	18,009 mm
A2	34,011 mm
Thread (Q)	1/8 NPT
Bearing number	RCJTY2-7/16
Bore Diameter (mm)	61,913