

Bearing No. FWF-11011830

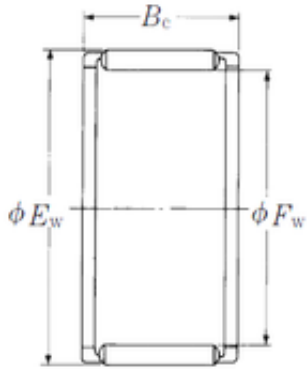

Fw	110 mm
Ew	118 mm
Bc	30 mm
Weight	0,195 Kg
Bearing number	FWF-11011830
Bore Diameter (mm)	110
Outer Diameter (mm)	118
Basic dynamic load rating (C)	78,5 kN
Basic static load rating (C0)	218 kN