

Bearing No. FWF-12012825

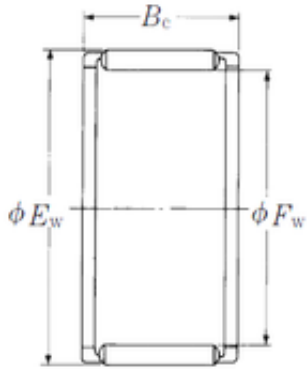

Fw	120 mm
Ew	128 mm
Bc	25 mm
Weight	0,19 Kg
Bearing number	FWF-12012825
Bore Diameter (mm)	120
Outer Diameter (mm)	128
Basic dynamic load rating (C)	69,5 kN
Basic static load rating (C0)	192 kN