

Bearing No. FWF-121610

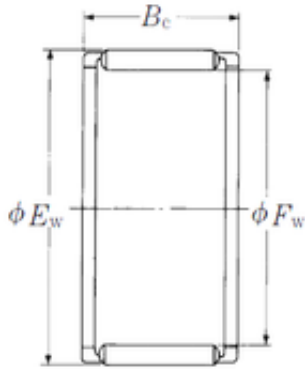

Fw	12 mm
Ew	16 mm
Bc	10 mm
Weight	0,0036 Kg
Bearing number	FWF-121610
Bore Diameter (mm)	12
Outer Diameter (mm)	16
Basic dynamic load rating (C)	5,7 kN
Basic static load rating (C0)	5,95 kN