

Bearing No. FWF-121713

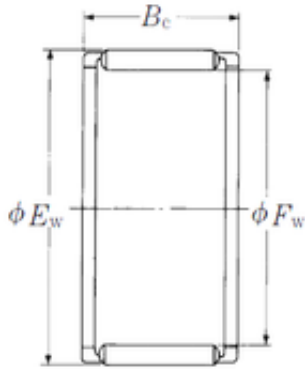

Fw	12 mm
Ew	17 mm
Bc	13 mm
Weight	0,006 Kg
Bearing number	FWF-121713
Bore Diameter (mm)	12
Outer Diameter (mm)	17
Basic dynamic load rating (C)	8,25 kN
Basic static load rating (C0)	8,35 kN